

9

MODULO

MOLPACO ARGENTINA
original parts refrigeration



PORTAPRECIOS



VALERI & BERTINO

PORTAPRECIOS FABRICADOS POR EXTRUSIÓN SIMPLE Y CO-EXTRUIDOS, ADAPTABLES A LOS DIFERENTES DISEÑOS DE EXHIBIDORES. PERMITEN SER COLOCADOS A PRESIÓN, ATORNILLADOS O ADHERIDOS CON CINTA DE DOBLE CONTACTO.



EXTRUSIÓN
DISEÑADA





FORMA DE PERFIL:	COMPUESTO:	PRESENTACIÓN:	COLOR:	CARACTERÍSTICAS:	PACKAGING:
EXTRUSIÓN SIMPLE	PVC	HASTA 6M	○ ● ○ ● ● ● ●	RÍGIDO	PP
CO-EXTRUSION	PVC / PVC CRISTAL	HASTA 6M	○ ● ○ ● ● ● ●	RÍGIDO	PP

LINEA DE PORTAPRECIOS EXTRUDADOS EN PVC RÍGIDO
ADAPTABLES A LOS DIFERENTES DISEÑOS DE EXHIBIDORES

PARA MAS INFORMACIÓN COMUNICARSE CON NUESTRA OFICINA TÉCNICA.
soporte@molpaco.com.ar

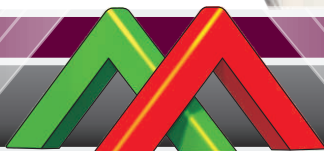

PORTAPRECIOS

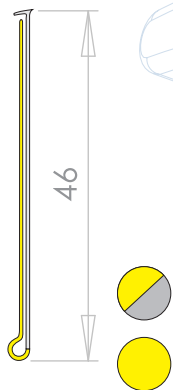

PP 462 U

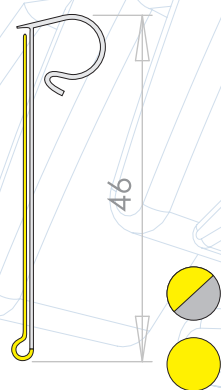

PP 4610 U

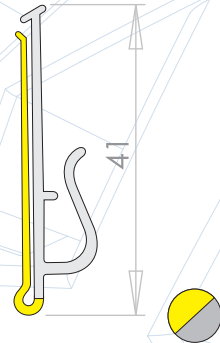

PP 4110 U

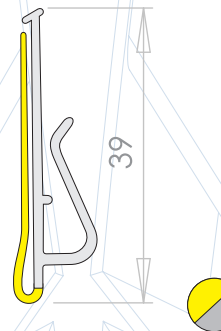

PP 3910 U

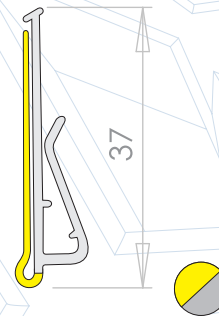

PP 3710 U

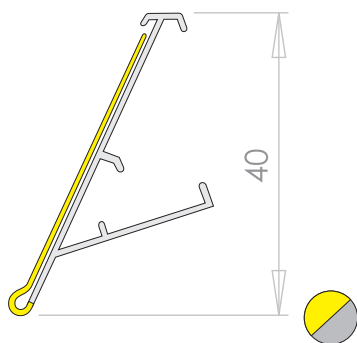

PP 4030 U

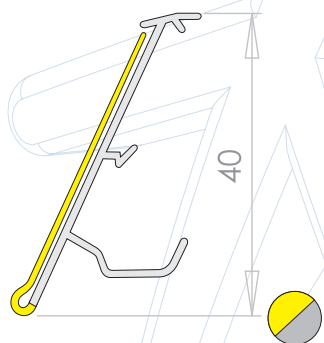

PP 4025 U

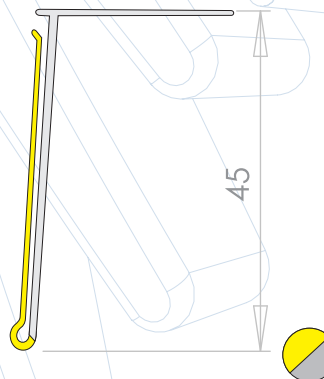

PP 4530 U

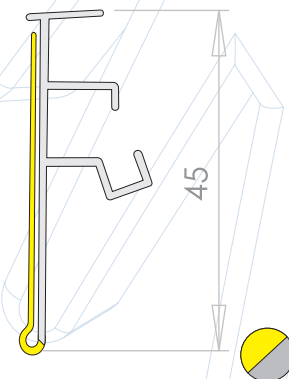

PP 4520 U

MATERIAS DE LOS PERFILES DE PVC:

 MATERIA CRISTAL Y PVC COEXTRUSIÓN

 MATERIA CRISTAL

PORTAPRECIOS

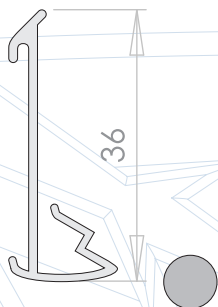

PP 3615 U

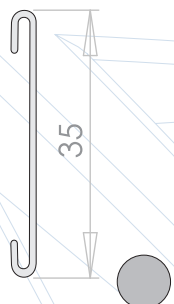

PP 354 U

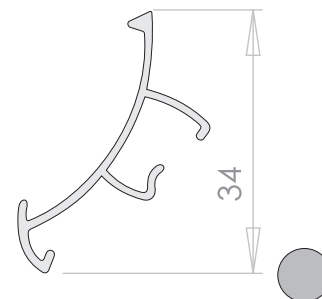

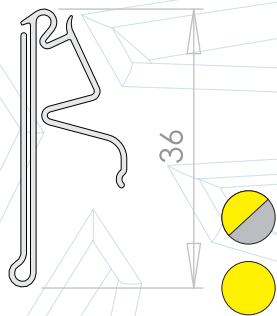

PP 3425 U

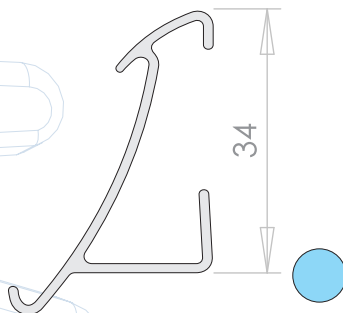

PP 3616 U



PP 3422 U

-  MATERIA PVC
-  MATERIA CRISTAL
-  MATERIA ALUMINIO

COLORES DE LOS PERFILES DE PVC: _____

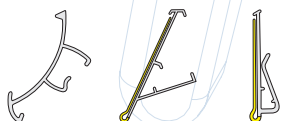



LONGITUD A PEDIDO DEL CLIENTE

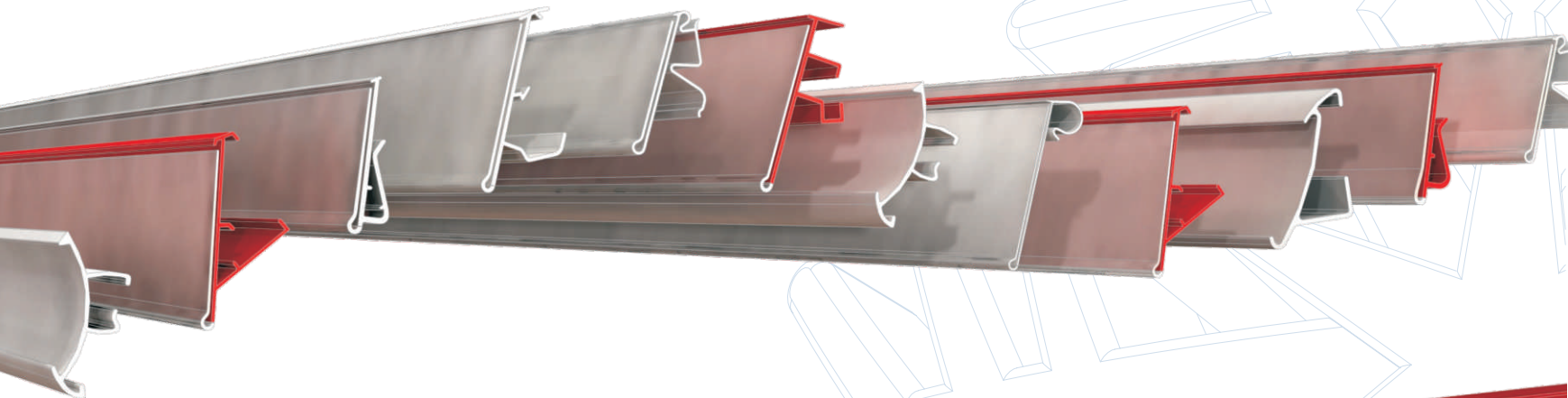



MOLPACO® ARGENTINA

EXPORTACIÓN - IMPORTACIÓN



Tel: (0341) 433 2028
Fax: (0341) 431 4976
molpaco@molpaco.com.ar
www.molpaco.com.ar

Cafferata 3229 / 3289
S2003EEI Rosario
Santa Fe
Argentina